



# 中华人民共和国国家标准

GB 324—88

---

## 焊缝符号表示法

Welds—symbolic representation on drawings

1988—12—10发布

1989—07—01实施

---

国家技术监督局 发布

# 目 次

1 主题内容及适用范围.....	( 1 )
2 引用标准.....	( 1 )
3 总则.....	( 1 )
4 符号.....	( 1 )
5 符号在图样上的位置.....	( 6 )
6 焊缝尺寸符号及其标注位置.....	( 9 )
7 符号应用举例 ( 见附录A ).....	( 14 )
附录A 符号应用举例 ( 补充件 ) .....	( 15 )

# 焊缝符号表示法

Welds—symbolic representation on drawings

代替 GB 324—80

本标准等效采用国际标准 ISO 2553—84 《焊缝在图样上的符号表示法》。

## 1 主题内容及适用范围

本标准规定了焊缝符号表示方法。

本标准适用于金属熔化焊及电阻焊。

## 2 引用标准

GB 5185 金属焊接及钎焊方法在图样上的表示代号

## 3 总则

3.1 为了简化图样上的焊缝一般应采用本标准规定的焊缝符号表示。但也可采用技术制图方法表示。

3.2 焊缝符号应明确地表示所要说明的焊缝，而且不使图样增加过多的注解。

3.3 焊缝符号一般由基本符号与指引线组成。必要时还可以加上辅助符号、补充符号和焊缝尺寸符号。图形符号的比例、尺寸和在图样上的标注方法，按技术制图有关规定。









3.4 为了方便，允许制定专门的说明书或技术条件，用以说明焊缝尺寸和焊接工艺等内容。必要时也可在焊缝符号中表示这些内容。

## 4 符号

### 4.1 基本符号

基本符号是表示焊缝横截面形状的符号见表 1。

表 1 基本符号

序号	名称	示意图	符号
1	卷边焊缝 <sup>1)</sup> (卷边完全熔化)		八
2	I 形焊缝		
3	V 形焊缝		V
4	单边V形焊缝		∇
5	带钝边V形焊缝		Y
6	带钝边单边V形焊缝		Y
7	带钝边U形焊缝		U
8	带钝边J形焊缝		J

续表 1

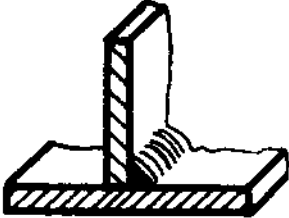
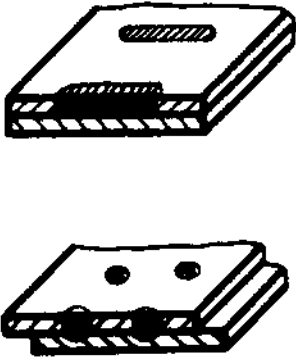
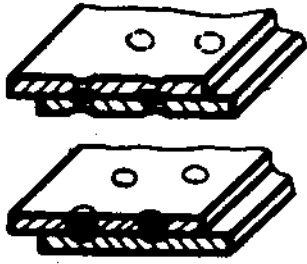
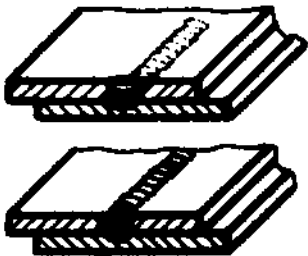

序号	名称	示意图	符号
9	封底焊缝		D
10	角焊缝		△
11	塞焊缝或槽焊缝		L
12	点焊缝		○
13	缝焊缝		⊕

注：1) 不完全熔化的卷边焊缝用 I 形焊缝符号来表示，并加注焊缝有效厚度  $S$ ，见表 7。

## 4.2 辅助符号





辅助符号是表示焊缝表面形状特征的符号，见表 2。

表 2 辅助符号

序号	名称	示意图	符号	说明
1	平面符号		—	焊缝表面齐平 (一般通过加工)
2	凹面符号		⌒	焊缝表面凹陷
3	凸面符号		⌒	焊缝表面凸起

不需要确切地说明焊缝的表面形状时，可以不用辅助符号。辅助符号的应用示例见表 3。









表 3 辅助符号的应用示例

名称	示意图	符号
平面V形对接焊缝		$\nabla$
凸面X对焊缝		$\bowtie$
凹面角焊缝		$\triangleleft$
平面封底V形焊缝		$\nabla$

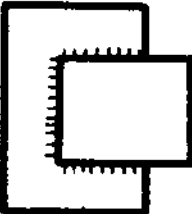
## 4.3 补充符号

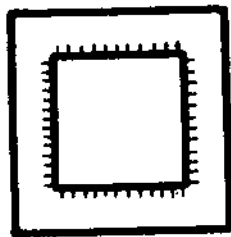
补充符号是为了补充说明焊缝的某些特征而采用的符号，见表4。

表4 补充符号



序号	名称	示意图	符号	说明
1	带垫板符号 <sup>1)</sup>			表示焊缝底部有垫板
2	三面焊缝符号 <sup>1)</sup>			表示三面带有焊缝
3	周围焊缝符号			表示环绕工件周围焊缝
4	现场符号			表示在现场或工地上进行焊接
5	尾部符号			可以参照GB 5185标注焊接工艺方法等内容

采用说明:

1) ISO 2553标准未作规定。

补充符号的应用示例见表 5。

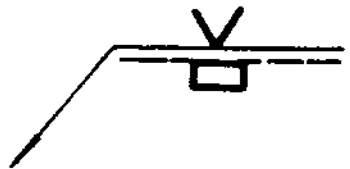
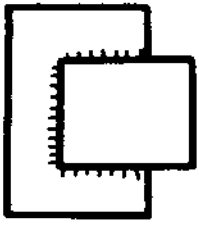
表 5 补充符号应用示例

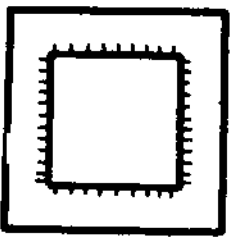
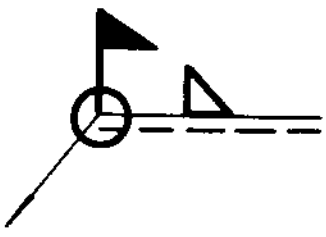
示意图	标注示例	说明
		<p>表示 V 形焊缝的背面底部有垫板</p>
		<p>工件三面带有焊缝，焊接方法为手工电弧焊</p>
		<p>表示在现场沿工件周围施焊</p>

## 5 符号在图样上的位置

### 5.1 基本要求

完整的焊缝表示方法除了上述基本符号、辅助符号、补充符号以外，还包括指引线、一些尺寸符号及数据。

指引线一般由带有箭头的指引线（简称箭头线）和两条基准线（一条为实线，另一条为虚线）两部分组成。如图 1 所示。





图 1 指引线

5.2 箭头线和接头的关系

图 2 和图 3 给出的示例说明下列术语的含义：

- a. 接头的箭头侧；
- b. 接头的非箭头侧。

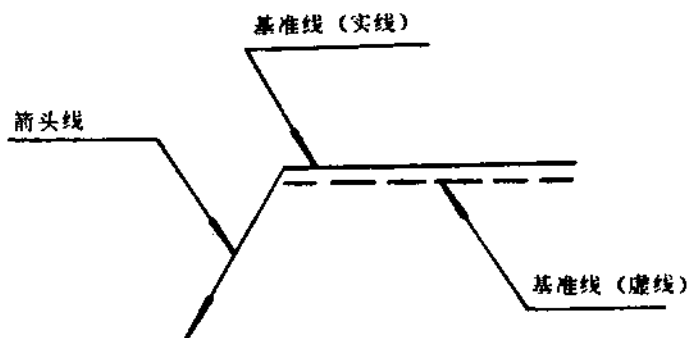

图 2 带单角焊缝的 T 型接头



图 3 双角焊缝十字接头

5.3 箭头线的位置

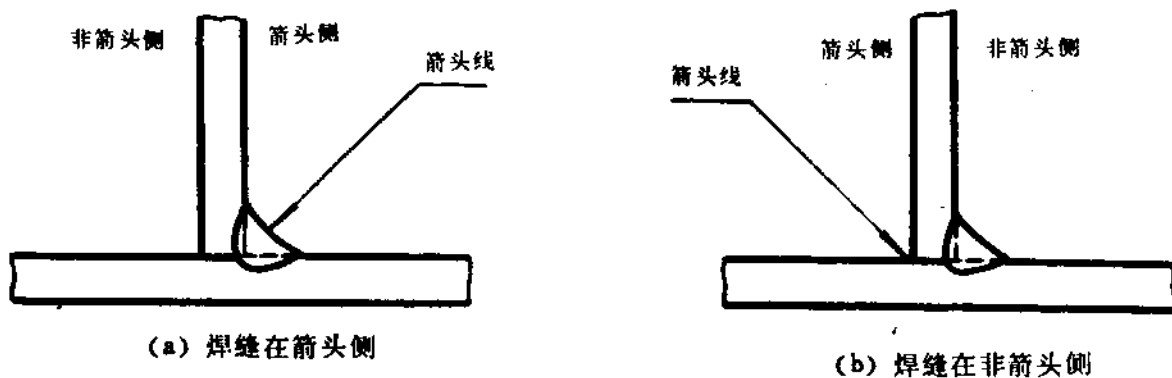
箭头线相对焊缝的位置一般没有特殊要求，见图 4 (a)、(b)。但是在标注 V、r、J 形焊缝

时，箭头线应指向带有坡口一侧的工件，见图4(c)、(d)。必要时，允许箭头线弯折一次，如图5。

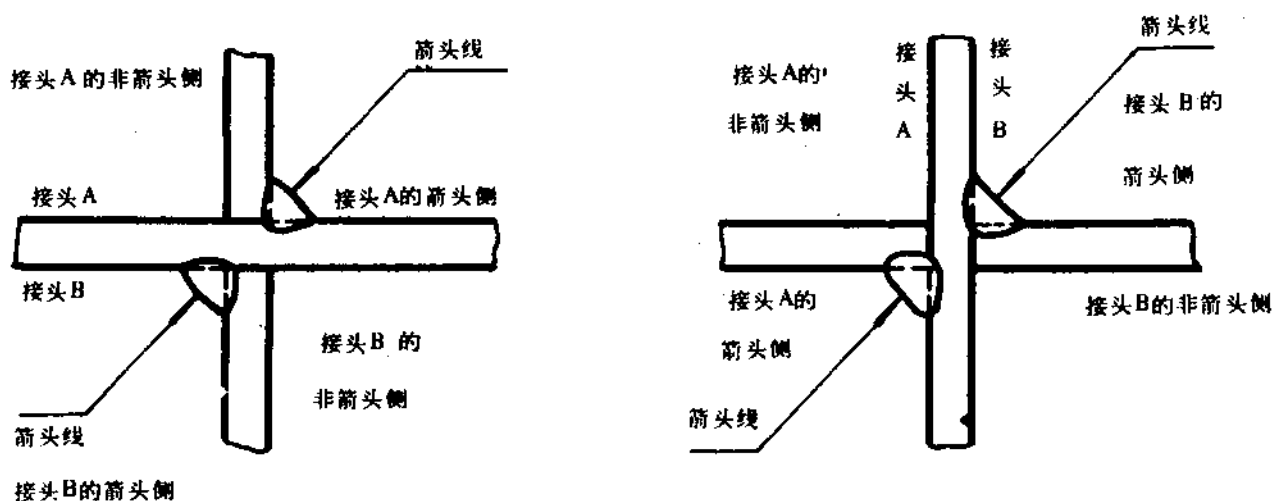

图 4 箭头线的位置



图 5 弯折的箭头线

## 5.4 基准线的位置

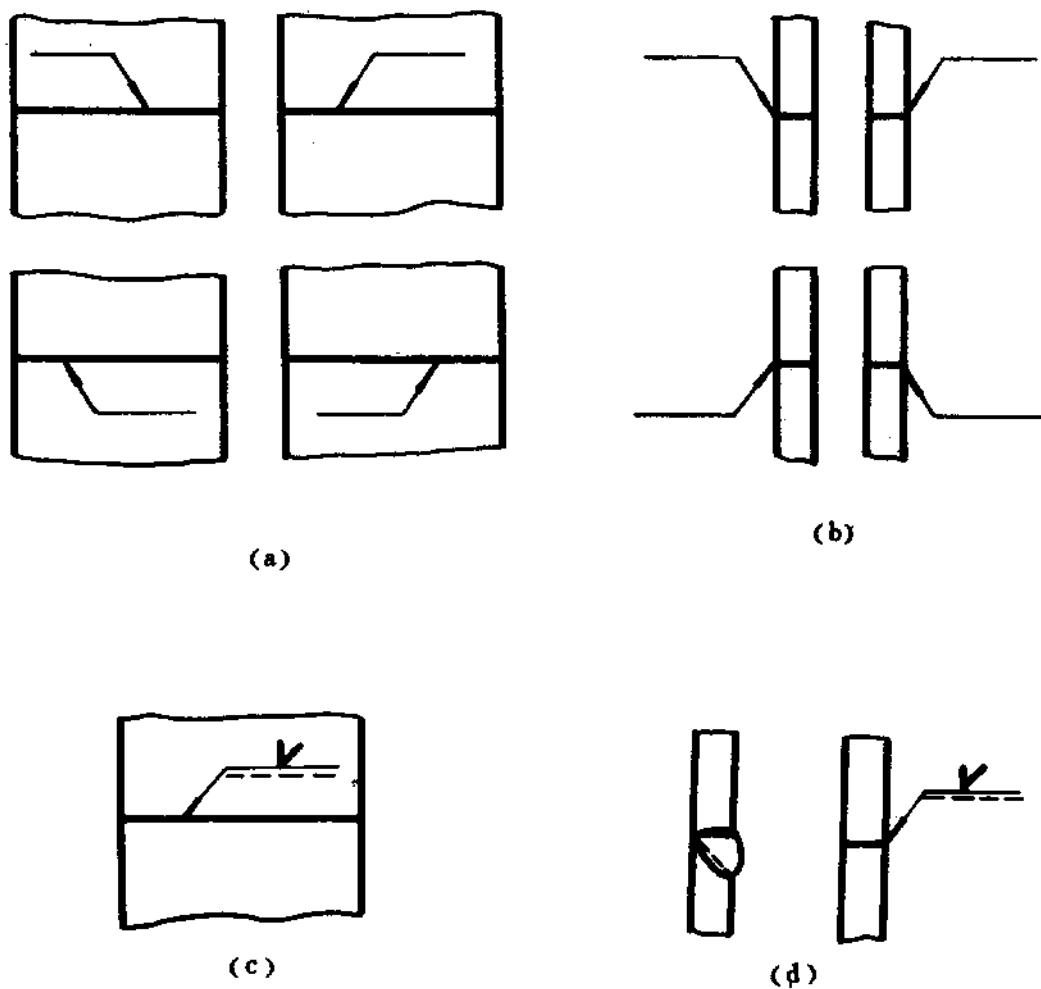
基准线的虚线可以画在基准线的实线下侧或上侧。

基准线一般应与图样的底边相平行，但在特殊条件下亦可与底边相垂直。

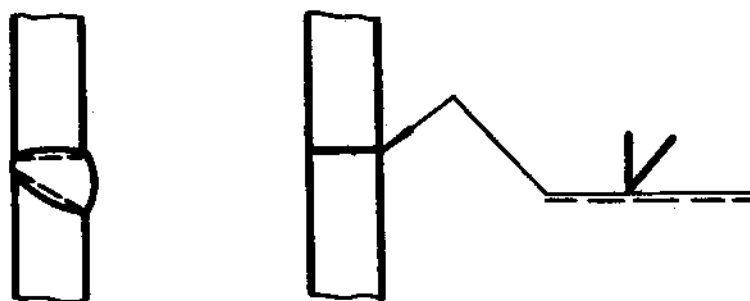
## 5.5 基本符号相对基准线的位置

为了能在图样上确切地表示焊缝的位置，特将基本符号相对基准线的位置作如下规定：

- a. 如果焊缝在接头的箭头侧，则将基本符号标在基准线的实线侧，见图 6(a)；
- b. 如果焊缝在接头的非箭头侧，则将基本符号标在基准线的虚线侧，见图 6(b)；
- c. 标对称焊缝及双面焊缝时，可不加虚线，见图 6(c)、(d)。











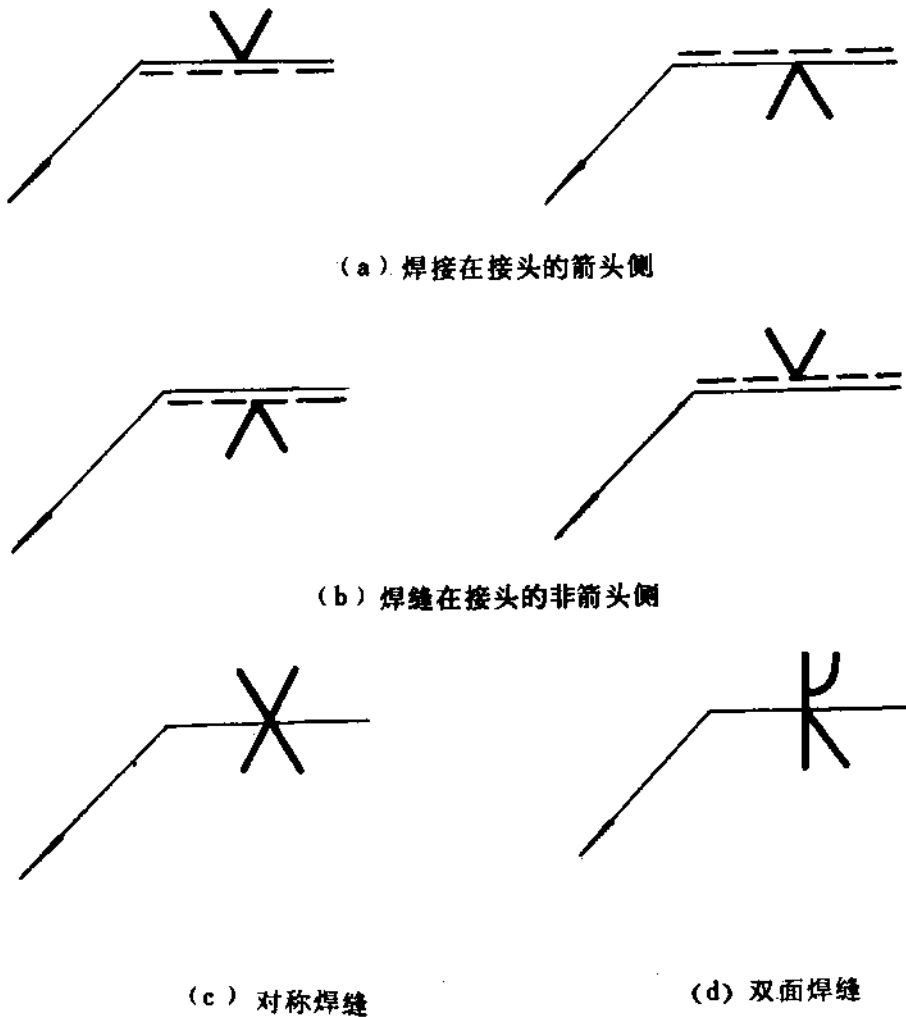

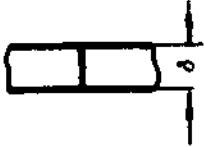
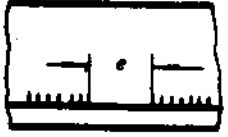
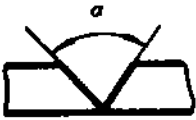

图 6 基本符号相对基准线的位置

## 6 焊缝尺寸符号及其标注位置

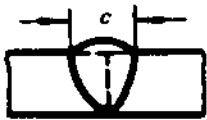
### 6.1 一般要求

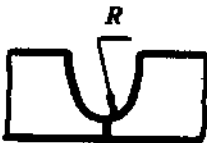
6.1.1 基本符号必要时可附带有尺寸符号及数据，这些尺寸符号见表 6。

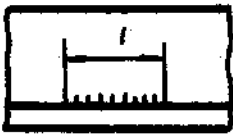
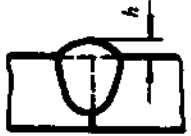
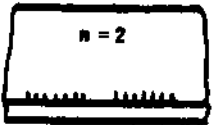
表 6 焊缝尺寸符号<sup>1)</sup>

符号	名称	示意图	符号	名称	示意图
$\delta$	工件厚度		$e$	焊缝间距	
$\alpha$	坡口角度		$K$	焊角尺寸	
$b$	根部间隙		$d$	熔核直径	
$p$	钝边		$S$	焊缝有效厚度	
$c$	焊缝宽度		$N$	相同焊缝数量符号	
$R$	根部半径		$H$	坡口深度	
$l$	焊缝长度		$h$	余高	
$n$	焊缝段数		$\beta$	坡口面角度	

采用说明:

1) 对焊缝尺寸符号, ISO 2553标准未作详细规定。

6.1.2 焊缝尺寸符号及数据的标注原则如图 7。

- a. 焊缝横截面上的尺寸标在基本符号的左侧；
- b. 焊缝长度方向尺寸标在基本符号的右侧；
- c. 坡口角度、坡口面角度、根部间隙等尺寸标在基本符号的上侧或下侧<sup>1)</sup>；
- d. 相同焊缝数量符号标在尾部<sup>2)</sup>；
- e. 当需要标注的尺寸数据较多又不易分辨时，可在数据前面增加相应的尺寸符号。当箭头线方向变化时，上述原则不变。



图 7 焊缝尺寸的标注原则

焊缝尺寸的标注示例见表 7。

表 7 焊缝尺寸的标注示例



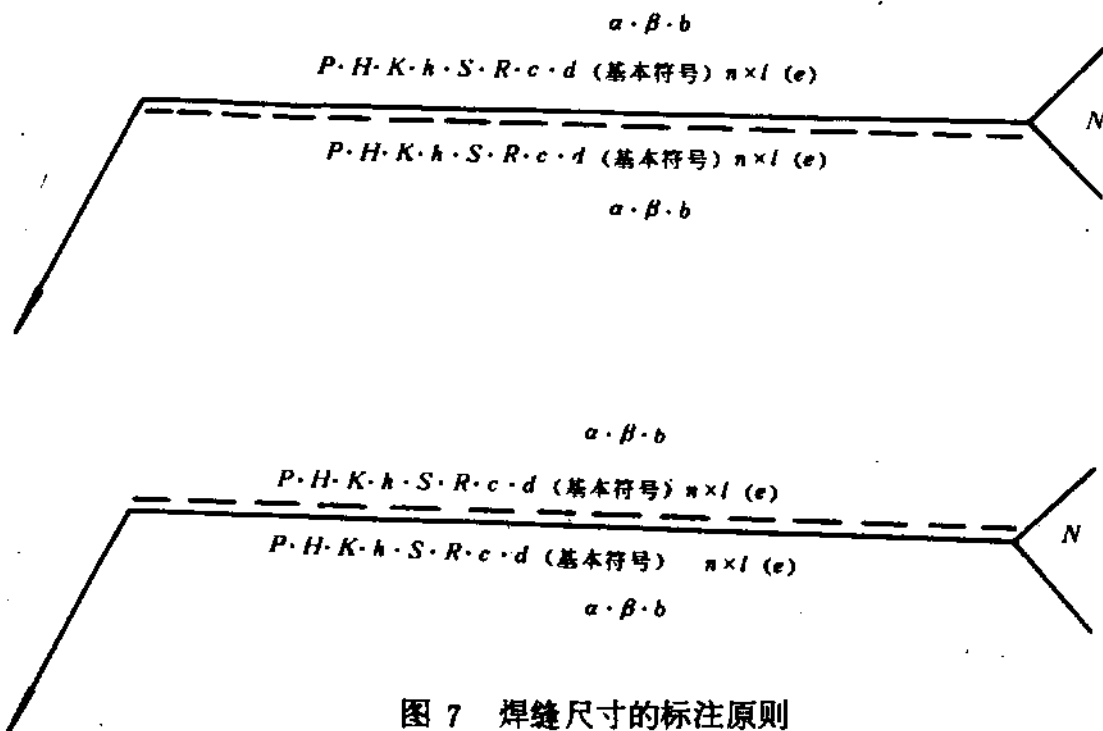

序号	名称	示意图	焊缝尺寸符号	示例
1	对接焊缝		S; 焊缝有效厚度	$S \nabla$
				$S \parallel$

采用说明，

1) ISO 2553 标准未作具体规定。

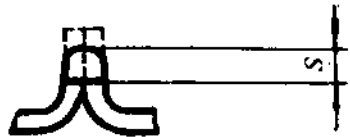
2) ISO 2553 标准对相同焊缝数量及焊缝段数未作明确区分，均用  $n$  表示。

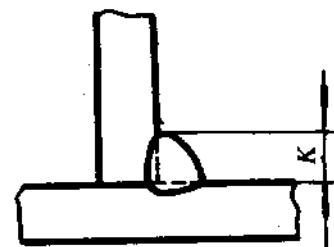
续表 7

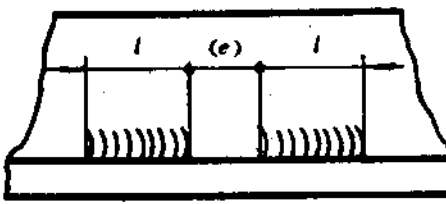
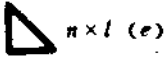
序号	名称	示意图	焊缝尺寸符号	示例
1	对接焊缝		S: 焊缝有效厚度	S Y
2	卷边焊缝		S: 焊缝有效厚度	S
				S 儿
3	连续角焊缝		K: 焊角尺寸 <sup>1)</sup>	K 
4	断续角焊缝		l: 焊缝长度 (不计弧坑) e: 焊缝间距 n: 焊缝段数	K 

采用说明:

1) ISO 2553标准规定角焊缝的尺寸标注采用 $a$ 、 $z$ 两种尺寸。

续表 7

序号	名称	示意图	焊缝尺寸符号	示例
5	交错断续角焊缝		$l$ $e$ $n$ } 见序号 4 $K$ : 见序号 3	
6	塞焊缝或槽焊缝		$l$ $e$ $n$ } 见序号 4 $c$ : 槽宽	$c$
			$n$ $e$ } 见序号 4 $d$ : 孔的直径	$d$
7	缝焊缝		$l$ $e$ $n$ } 见序号 4 $c$ : 焊缝宽度	$c$
8	点焊缝		$n$ : 见序号 4 $e$ : 间距 $d$ : 焊点直径	$d$

## 6.2 关于尺寸符号的说明

6.2.1 确定焊缝位置的尺寸不在焊缝符号中给出，而是将其标注在图样上。

6.2.2 在基本符号的右侧无任何标注且又无其他说明时，意味着焊缝在工件的整个长度上是连续的。

6.2.3 在基本符号的左侧无任何标注且又无其他说明时，表示对接焊缝要完全焊透。

6.2.4 塞焊缝，槽焊缝带有斜边时，应该标注孔底部的尺寸。

## 7 符号应用举例（见附录A）



附录 A<sup>1)</sup>  
符号应用举例  
(补充件)





- A1** 基本符号的应用举例见表A 1
- A2** 基本符号的组合举例  
基本符号的组合举例见表A 2。
- A3** 基本符号与辅助符号的组合举例  
基本符号与辅助符号的组合应用举例见表A 3。
- A4** 特殊情况举例<sup>1)</sup>  
喇叭形焊缝、单边喇叭形焊缝、堆焊缝及锁边焊缝的标注见表A 4。
- A5** 错误标注示例见表A 5

---

采用说明:

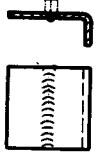
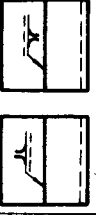
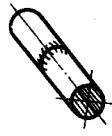
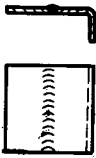
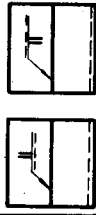
- 1) 本标准采用了ISO 2553标准中具有代表性的应用示例,但对ISO 2553标准中的附录B 因不适合于我国国情未采用。
- 2) ISO 2553标准没有此内容。

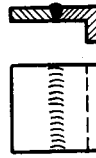
表 A1 基本符号应用举例

序号	符号	示意图	图 示 法	标 注 方 法
1	八			
2				
3	>			

续表 A1

序号	符号	示意图	图示法	标注方法
4	∨			
5	Y			
6	Y			

续表 A1

序号	符号	示意图	图. 示 法	标 注 方 法
7				
8				
9				

续表 A1

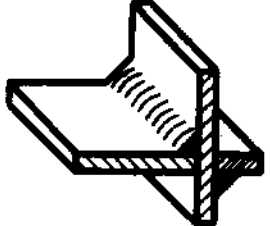
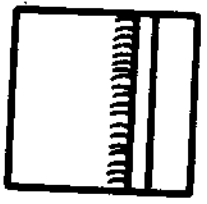
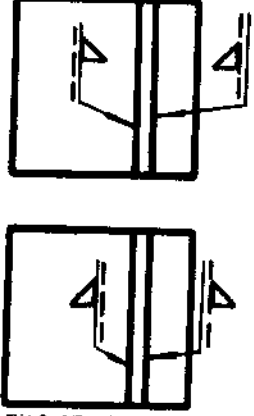
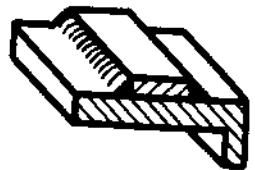
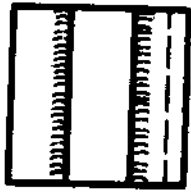
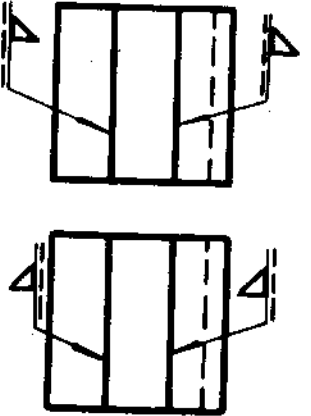
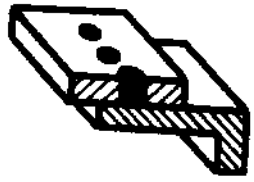
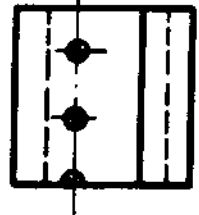
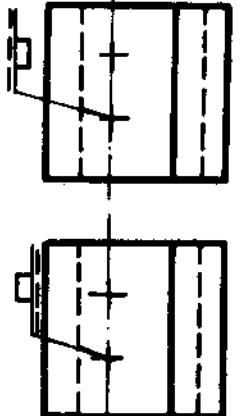
序号	符号	示意图	图示法	标注方法
	△			
				
10	┌			

续表 A1

序号	符号	示意图	图示法	标注方法	
11					
	○				

续表 A1











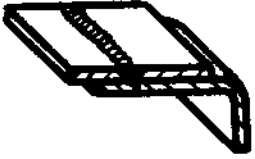
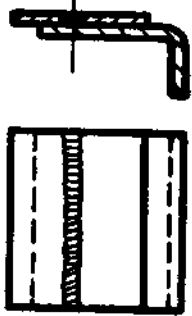
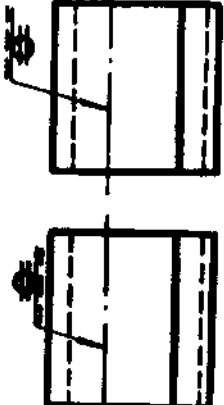
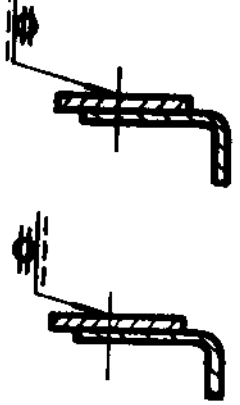

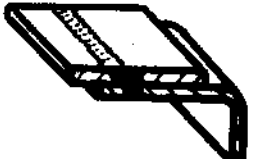
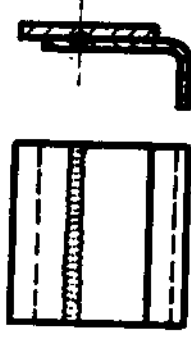
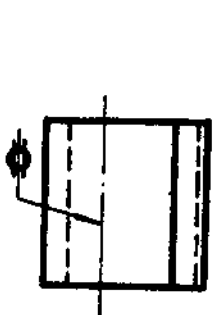
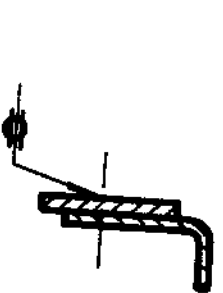

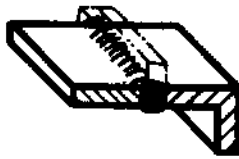
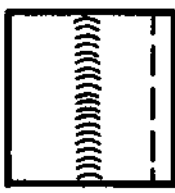

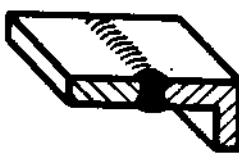
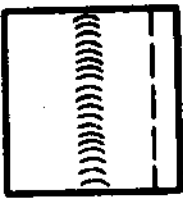

序号	符号	示意图	图示法	标注法	方法
					
					

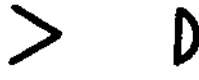
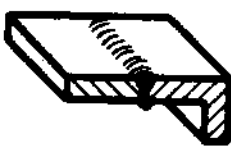
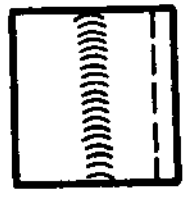
表 A2 基本符号的组合举例

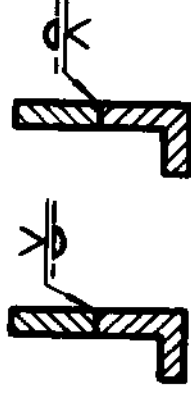
序号	符号组合	示意图	图 示 法	标 注 方 法
1			 	
2	双面 		 	
3			 	

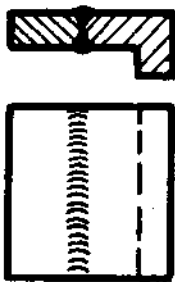
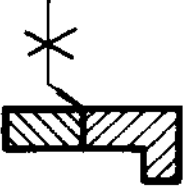

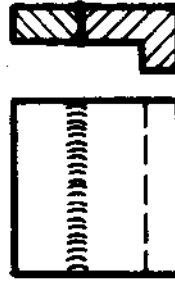
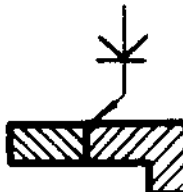
续表 A2

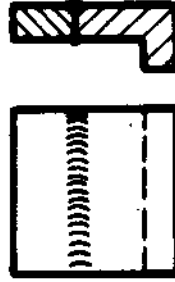
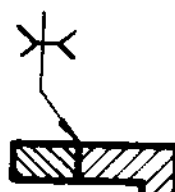
序号	符号组合	示意图	图示法	标注方法
4	双面 			
5	双面 			
6	双面 			

续表 A2

序号	符号组合	示意图	图示法	标注法	方法
7	双面 Y				
8	双面 Y				
9	双面 Y				

续表 A2







序号	符号组合	示意图	图示法	标注法	方法
10					
11					
					



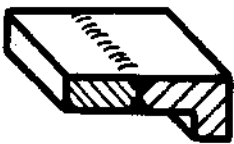
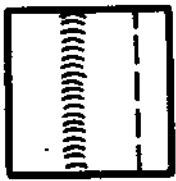
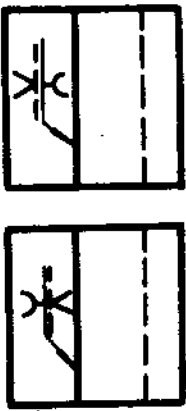
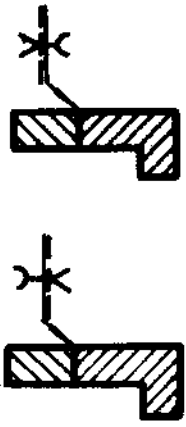

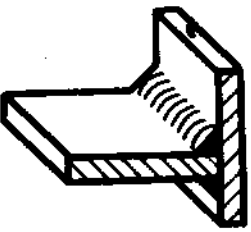
表 A3 基本符号与辅助符号的组合举例

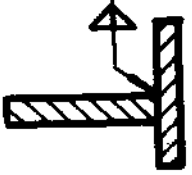
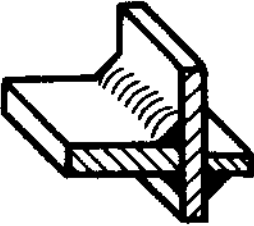
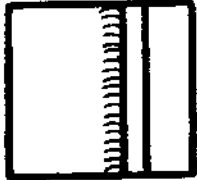
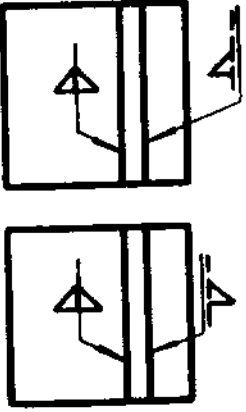
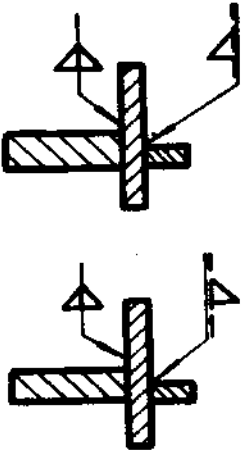
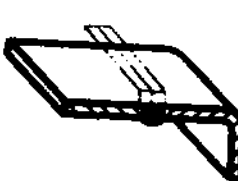
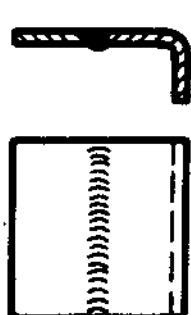
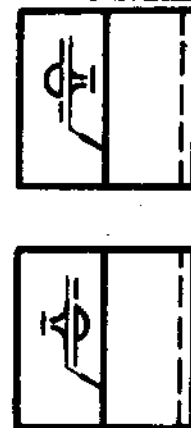
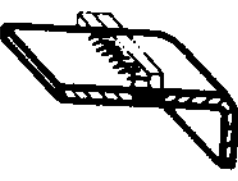
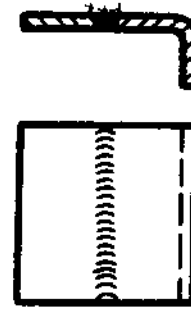
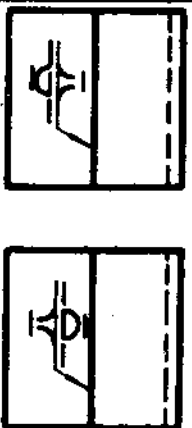
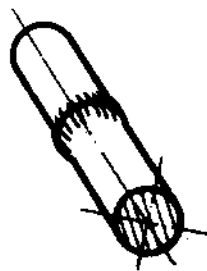
序号	符号组合	示意图	图 示 法	标 注 方 法
1	⌈			
2	⌋			
3	⌈⌋			

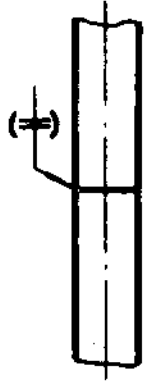
续表 A3

序号	符号组合	示意图	图示法	标注方法
4				
5				
6				
7				

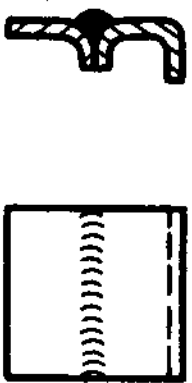
表 A4 特殊焊缝的标注

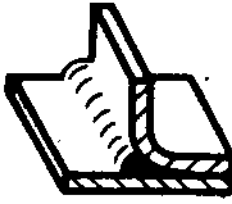
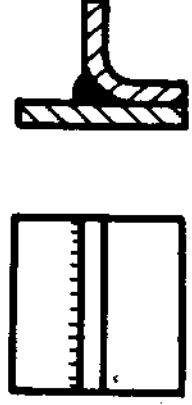
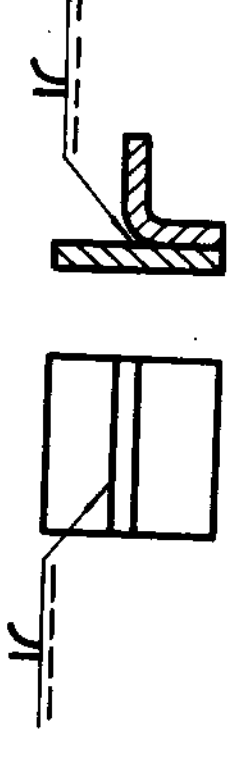
序号	符号	示意图	图 示 法	标 注 方 法
1				
2				

续表 A4









序号	符号	示意图	图示法	标注方法
3				
4				

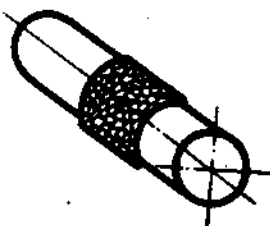



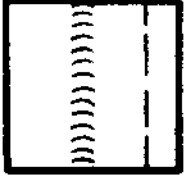
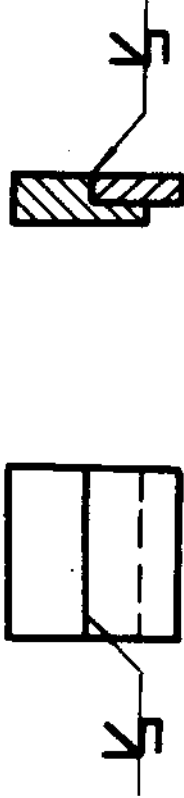

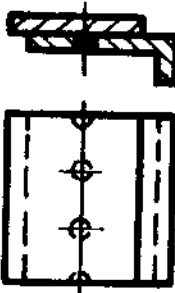
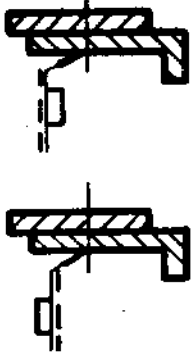
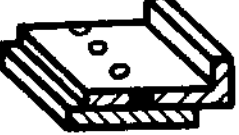
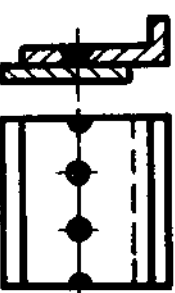
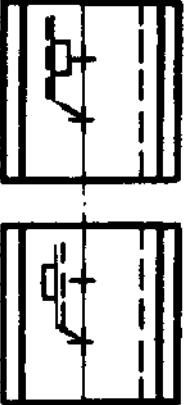
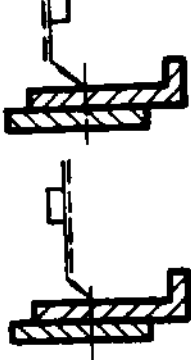

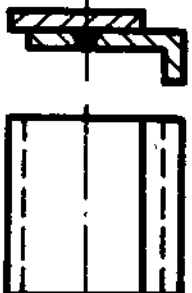
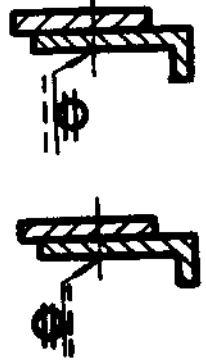
表 A.5 错误标注示例

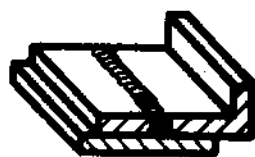
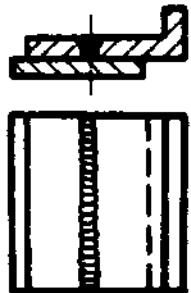
序号	示意图	图 示 法	标 注 方 法	错 误 标 法
1			—	
2				
3			—	

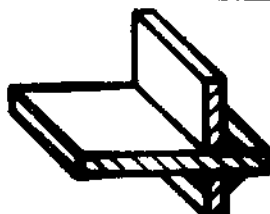
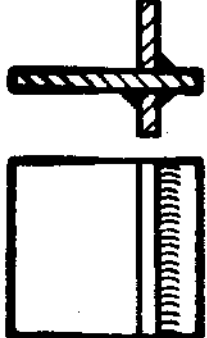

注：当箭头线指不到所要表示的接头时，不可采用焊缝符号标注方法。

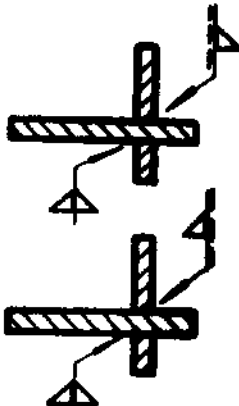
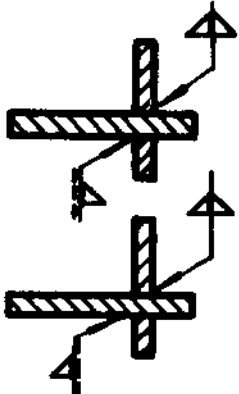
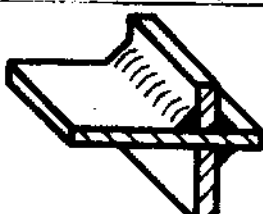
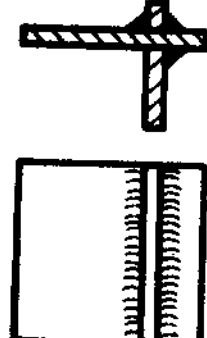

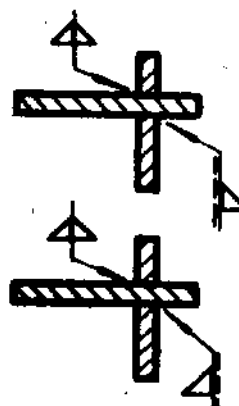
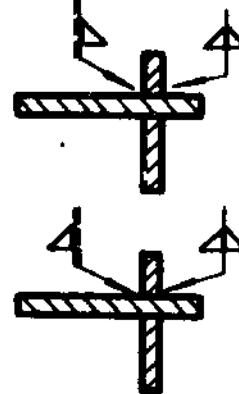
续表 A5

序号	示意图	图 示 法	标 注 方 法	方 法	错 误 标 法
4					
5					
6					

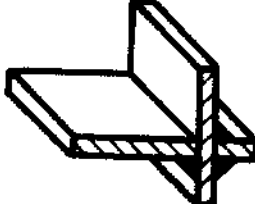
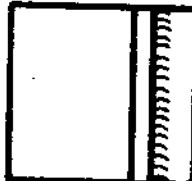
续表 A5

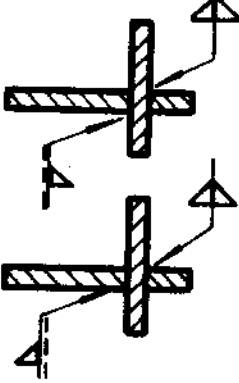
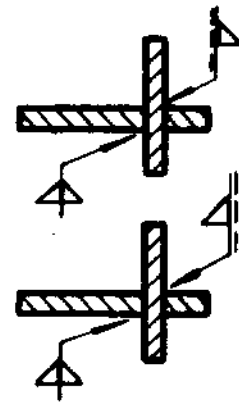
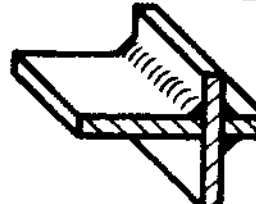
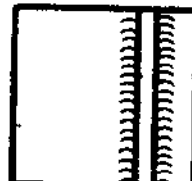
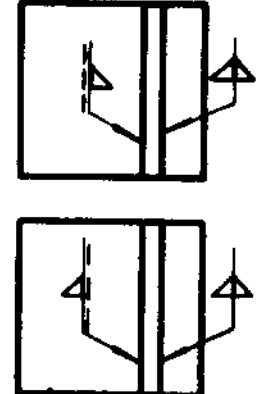
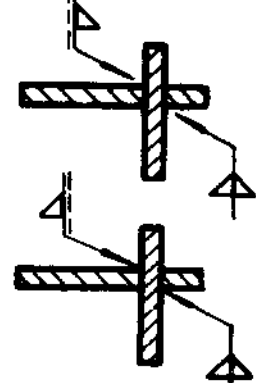
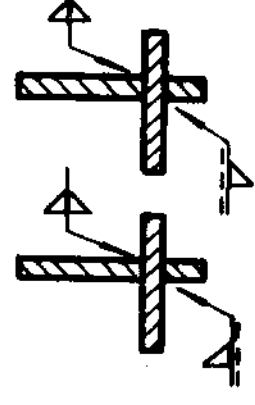
序号	示意图	图 示 法	标 注 法	方 法	错 误 标 法
7					
8					

**附加说明：**

本标准由中华人民共和国机械电子工业部提出。

本标准由哈尔滨焊接研究所归口。

本标准由哈尔滨焊接研究所起草。

中华人民共和国  
国家标准  
焊缝符号表示法  
GB 324—88

中国标准出版社出版  
(北京复外三里河)

中国标准出版社北京印刷厂印刷  
新华书店北京发行所发行 各地新华书店经售  
版权专有 不得翻印

开本 880×1230 1/16 印张 2 字数 63 000  
1989年10月第一版·1989年10月第一次印刷  
印数 1—60 000

书号: 155066·1—6377 定价 1.20 元

标目 116—4

